





EVOAQ Ventilation Controller



- M** Mode
-  Ventilation Rate Adjust
-  Power ON/OFF
-  Adjust Set Temperature Up
-  Adjust Set Temperature Down

Please read all instructions before commencing installation.

Automated Touch Screen Overview



This digital controller has been specifically designed to ensure the best possible ventilation for your home. The large screen is designed to measure the indoor air temperature using a high precision built-in sensor.

The digital controller communicates your ventilation requirement to the intelligent fan control board which is constantly sensing the air quality and adjusting the fan speed. By selecting the ventilation rate this control board will increase/decrease the overall amount of ventilation to your house. This ventilation requirement is adjusted according to your Set Comfort Temperature in Auto mode.

No further inputs or adjustments are required. **Simply set and forget.**

Display Information

Off  Turn system off. The system will switch to shutdown mode and stop after several minutes.

Set Comfort Temperature – The controller adjusts the ventilation requirement according to the set temperature. Adjust the set temperature using the Adjust Up  and Down  buttons.

Mode **M** Switch between Summer and Winter mode





 Summer - Heat Transfer OFF (heat transfer upgrade) / Air is taken from outside (summer kit)

 Winter - Heat Transfer ON (heat transfer) / Air is taken from the roof space (summer kit)

NB Without the respective add-on kits installed the mode selection does not affect system operation.

Setting your Ventilation Requirement

Adjust the set ventilation with the Ventilation Rate Adjust  button. The setting will cycle through the following options:

-  **High ventilation** - Fan will operate at higher speeds across a wider range of temperature to actively work on Air Quality and condensation (30-100% speed).
-  **Medium ventilation** - Fan will operate at medium airflows (20-80% speed).
-  **Low ventilation** - Fan will provide lower airflows while maintaining air quality (10-60% speed) - *recommended default setting*
-  **Auto ventilation** - Controller selects Low, Medium or High Ventilation rate depending on the difference between the room temperature and your comfort set temperature. The closer the two temperatures, the higher the ventilation rate.

Mounting Instructions & Installation

1. Open the thermostat by pushing in the tabs located on the bottom of the unit (figure 1a and 1b) and remove the interconnect cable.
2. Choose a mounting position on the wall and cut a 64 mm diameter hole in the wall gip, avoiding any structure timber framing.
3. See Connection Diagrams for connecting to the fan using the provided data cable.
4. After connecting the required wiring, mount the base of the controller with the 4 screws provided (figure 2), noting the top direction.
5. Reconnect the interconnect cable to the display front.
6. Replace the cover by locating the two tabs at the top of the unit and lever the touch screen on as shown (figure 3). As you close the unit ensure the two plastic tabs at the bottom clip into place.

Note: Do not use excessive force to fit the cover.

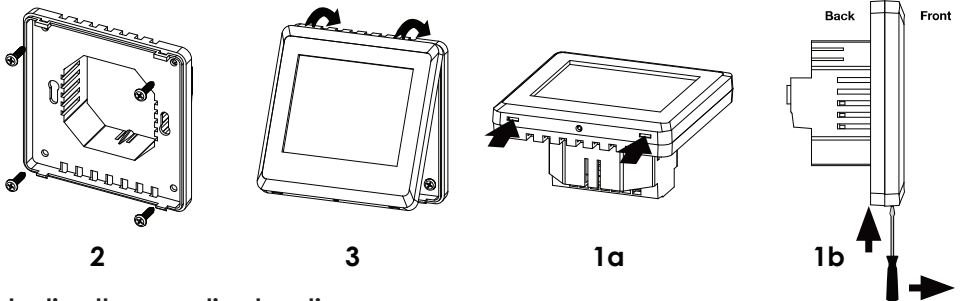

Selecting the mounting location

- The controller is for internal use only.
- Mount approx. 1.5 metres above the floor on an inner wall. Select the wall for ease of wiring to the fan.
- Avoid locations which are not easily affected by changes in the room temperature.
- Do not mount on hot surfaces or surfaces exposed to direct sunlight.
- Do not install in damp or wet areas like the laundry or bathrooms.

Connection Diagram

If your system includes add-ons such as an EVOAQ Summer Upgrade Kit please note that the wiring may differ from the below image; refer to the respective upgrade kit manual for correct wiring.

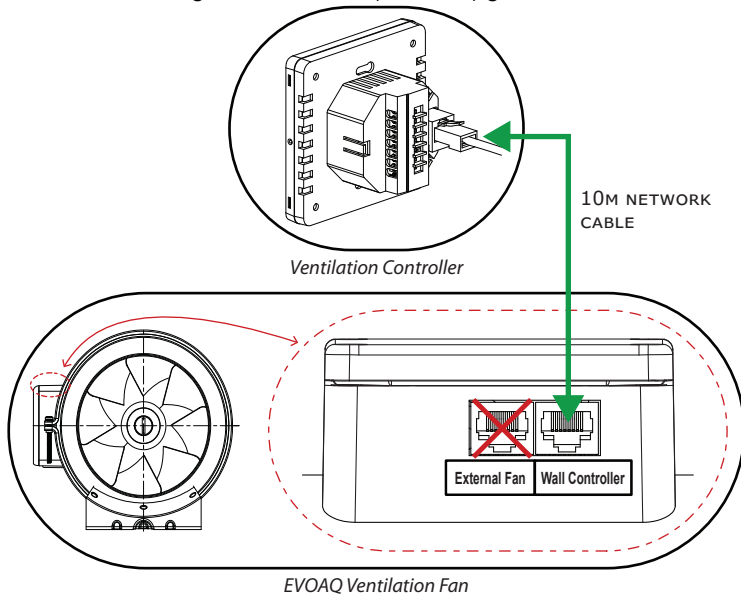

Frequently Asked Questions

Which ventilation rate should I choose?

- **Low ventilation** is suitable for low occupancy numbers in the house and/or when total ventilation requirements may be substituted with opening windows and doors (e.g. during summer time). This is the ventilation rate we recommend you aim for at all times, only increasing the rate to medium and high rates if there are signs of inadequate ventilation.
- **Medium Ventilation** provides ventilation requirements for an average, well-insulated home.
- **High Ventilation** is suitable when there is a higher occupancy in the home or signs of poor air quality due to increased moisture levels in the house (e.g. condensation).
- **Auto mode** maintains the requirements of the three rates based on temperature in the home. As well as providing the correct levels of ventilation, the system also tries to normalise the indoor air temperature to the target comfort level set by the user.

What set temperature should I select?

We recommend a set temperature of 22°C. Generally, the set temperature does not affect the system operation - except in auto mode - however, if the room and set temperatures are more than 5°C separated, the ventilation rate will switch to Low. To keep the ventilation system working optimally, a set temperature close to the usual room temperature in the house is best.

I changed the controller speed or turned it off, why can't I hear the fan changing speeds?

The fan includes internal controls that determine its speed, which can range from 10 - 100% speed. To prevent noise issues the fan only changes speed very slowly so you won't hear it do so.

Advanced Controller Functions

Locking the controller



To lock the controller, press and hold the Adjust Up ▲ and Down ▼ buttons together.

The lock symbol  appears in the middle-left of the display.

To unlock the controller, repeat as above.

Calibrating the room temperature

1. Enter programming mode

- Turn off your controller with the Power Off  button.
- Press and hold the Ventilation Rate Adjust  button for 5 seconds.
- Release the button when the screen turns on.

2. Adjust the calibration value shown in the middle of the display

- Adjust the calibration value using the Adjust Up ▲ and Down ▼ buttons.
- Press the Power Off  button to return to the home screen. The controller will turn off automatically after 5 seconds of no activity in programming mode.

The calibration value is added or subtracted (if negative) to the room temperature.

Example: The room temperature is 22°C and the controller displays 20°C. The current calibration value is -1°C → change the calibration value to 1°C.

Technical Specifications

Set Temperature Range:	5 - 35°C
Temperature Resolution:	0.5°C
Operating Voltage/Frequency:	12 - 24 Volt DC
Sensing Element:	NTC Thermistor
Operating Temperature:	0 - 40°C
Operating Humidity:	5 - 90% non-condensing
Output Control:	Digital control interface
Display:	3.5" digital LCD touchscreen
Approval:	All relevant AS/NZS standards
EMC Approval:	All relevant AS/NZS standards

The system should be checked annually and the filter changed at least every 2 years.

This controller has been designed to only work with EVOAQ Ventilation System EC Fans

EvolutionFX Limited reserves the right to change specifications or designs described in this document without notice and without obligation.

For further information, please contact EvolutionFX Limited

Email: info@evolutionfx.co.nz

Phone: +64 9 558 5590